

# ***MATERIAL LIST***

## **ALU 2000 / STEEL 2000** **FORMWORK**

### Contents

<b>Panels</b>	<b>2-5</b>
Panels	2-3
AL 2000 (Finnish & Plastic Plywood)	2
ST 2000 (Finnish & Plastic Plywood)	3
Corners	4
Dismantling Devices; Compensation panels	5
Radius Panels	5
<b>Accessories</b>	<b>6-7</b>
Connecting Material	6
Anchoring Material	6
Push and Pull Props	7
Brace Frame "L"	7
Concreting Brackets	7
Concreting Platform	7
Crane Hook	7
Transportation and Storage	7
<b>Lost Parts</b>	<b>8</b>
Release Agent and Syringe	8
Spacer Tubes	8
Tie Cones	8
<b>Additional Accessories</b>	<b>8</b>



## Frame panels

### AL 2000 270 with finnish plywood

ITEM	DIMENSIONS	ITEM NR.	WEIGHT
AL 2000 - Panel 270/90	270 x 90 x 10 cm	431 90	49,00 kg
AL 2000 - Panel 270/60	270 x 60 x 10 cm	431 60	40,00 kg
AL 2000 - Panel 270/50	270 x 50 x 10 cm	431 50	35,00 kg
AL 2000 - Panel 270/45	270 x 45 x 10 cm	431 45	33,00 kg
AL 2000 - Panel 270/30	270 x 30 x 10 cm	431 30	25,00 kg
AL 2000 - Panel 270/25	270 x 25 x 10 cm	431 25	23,00 kg

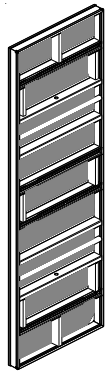

### AL 2000 135 with finnish plywood

ITEM	DIMENSIONS	ITEM NR.	WEIGHT
AL 2000 - Panel 135/90	135 x 90 x 10 cm	432 90	25,00 kg
AL 2000 - Panel 135/60	135 x 60 x 10 cm	432 60	20,00 kg
AL 2000 - Panel 135/50	135 x 50 x 10 cm	432 50	17,00 kg
AL 2000 - Panel 135/45	135 x 45 x 10 cm	432 45	16,00 kg
AL 2000 - Panel 135/30	135 x 30 x 10 cm	432 30	11,00 kg
AL 2000 - Panel 135/25	135 x 25 x 10 cm	432 25	10,00 kg

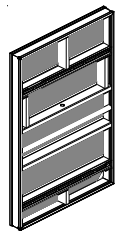

### AL 2000 270 with plastic coated plywood

ITEM	DIMENSIONS	ITEM NR.	WEIGHT
AL 2000 - Panel plastic E 270/90	270 x 90 x 10 cm	E431 90	52,00 kg
AL 2000 - Panel plastic E 270/60	270 x 60 x 10 cm	E431 60	42,00 kg
AL 2000 - Panel plastic E 270/50	270 x 50 x 10 cm	E431 50	37,00 kg
AL 2000 - Panel plastic E 270/45	270 x 45 x 10 cm	E431 45	34,00 kg
AL 2000 - Panel plastic E 270/30	270 x 30 x 10 cm	E431 30	26,00 kg
AL 2000 - Panel plastic E 270/25	270 x 25 x 10 cm	E431 25	24,00 kg

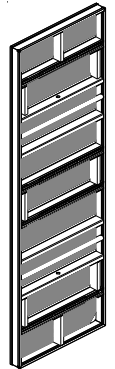

### AL 2000 135 with plastic coated plywood

ITEM	DIMENSIONS	ITEM NR.	WEIGHT
AL 2000 - Panel plastic E 135/90	135 x 90 x 10 cm	E432 90	26,00 kg
AL 2000 - Panel plastic E 135/60	135 x 60 x 10 cm	E432 60	21,00 kg
AL 2000 - Panel plastic E 135/50	135 x 50 x 10 cm	E432 50	18,00 kg
AL 2000 - Panel plastic E 135/45	135 x 45 x 10 cm	E432 45	16,00 kg
AL 2000 - Panel plastic E 135/30	135 x 30 x 10 cm	E432 30	12,00 kg
AL 2000 - Panel plastic E 135/25	135 x 25 x 10 cm	E432 25	11,00 kg

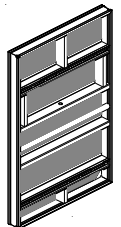

### AL 2000 Multi Purpose Panles

ITEM	DIMENSIONS	ITEM NR.	WEIGHT
AL 2000 - Multi Purpose Panel 270/90 finnish plywood	270 x 90 x 10 cm	431 901	53,00 kg
AL 2000 - Multi Purpose Panel 135/90 finnish plywood	135 x 90 x 10 cm	431 903	28,00 kg
AL 2000 - Mutli Purpose Panel plastic plywood E 270/90	270 x 90 x 10 cm	E432 901	56,00 kg
AL 2000 - Mutli Purpose Panel plastic plywood E1350/90	135 x 90 x 10 cm	E431 903	29,00 kg

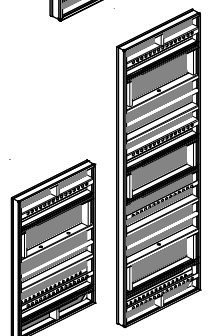

**Other panel widths are available upon request !**

# PANELS

## Frame panels

### ST 2000 270 with finnish plywood

ITEM	DIMENSIONS	ITEM NR.	WEIGHT
ST 2000 - Panel 270/90 galvanized	270 x 90 x 10 cm	531 90	79,50 kg
ST 2000 - Panel 270/60 galvanized	270 x 60 x 10 cm	531 60	64,00 kg
ST 2000 - Panel 270/50 galvanized	270 x 50 x 10 cm	531 50	55,00 kg
ST 2000 - Panel 270/45 galvanized	270 x 45 x 10 cm	531 45	50,00 kg
ST 2000 - Panel 270/40 galvanized	270 x 40 x 10 cm	531 40	46,00 kg
ST 2000 - Panel 270/30 galvanized	270 x 30 x 10 cm	531 30	41,00 kg
ST 2000 - Panel 270/25 galvanized	270 x 25 x 10 cm	531 25	37,00 kg

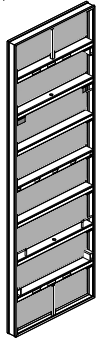

### ST 2000 135 with finnish plywood

ITEM	DIMENSIONS	ITEM NR.	WEIGHT
ST 2000 - Panel 135/90 galvanized	135 x 90 x 10 cm	532 90	42,00 kg
ST 2000 - Panel 135/60 galvanized	135 x 60 x 10 cm	532 60	31,00 kg
ST 2000 - Panel 135/50 galvanized	135 x 50 x 10 cm	532 50	29,00 kg
ST 2000 - Panel 135/45 galvanized	135 x 45 x 10 cm	532 45	27,00 kg
ST 2000 - Panel 135/40 galvanized	135 x 40 x 10 cm	532 40	25,00 kg
ST 2000 - Panel 135/30 galvanized	135 x 30 x 10 cm	532 30	22,00 kg
ST 2000 - Panel 135/25 galvanized	135 x 25 x 10 cm	532 25	18,00 kg

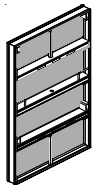

### ST 2000 270 with plastic coated plywood (available upon request)

ITEM	DIMENSIONS	ITEM NR.	WEIGHT
ST 2000 - Panel plastic E 270/90 galvanized	270 x 90 x 10 cm	E531 90	83,00 kg
ST 2000 - Panel plastic E 270/60 galvanized	270 x 60 x 10 cm	E531 60	66,00 kg
ST 2000 - Panel plastic E 270/50 galvanized	270 x 50 x 10 cm	E531 50	57,00 kg
ST 2000 - Panel plastic E 270/45 galvanized	270 x 45 x 10 cm	E531 45	51,00 kg
ST 2000 - Panel plastic E 270/40 galvanized	270 x 40 x 10 cm	E531 40	47,00 kg
ST 2000 - Panel plastic E 270/30 galvanized	270 x 30 x 10 cm	E531 30	42,00 kg
ST 2000 - Panel plastic E 270/25 galvanized	270 x 25 x 10 cm	E531 25	38,00 kg

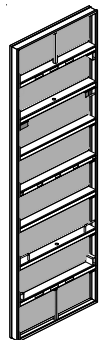

### ST 2000 135 with plastic coated plywood (available upon request)

ITEM	DIMENSIONS	ITEM NR.	WEIGHT
ST 2000 - Panel plastic E 135/90 galvanized	135 x 90 x 10 cm	E532 90	43,00 kg
ST 2000 - Panel plastic E 135/60 galvanized	135 x 60 x 10 cm	E532 60	32,00 kg
ST 2000 - Panel plastic E 135/50 galvanized	135 x 50 x 10 cm	E532 50	30,00 kg
ST 2000 - Panel plastic E 135/45 galvanized	135 x 45 x 10 cm	E532 45	28,00 kg
ST 2000 - Panel plastic E 135/40 galvanized	135 x 40 x 10 cm	E532 40	26,00 kg
ST 2000 - Panel plastic E 135/30 galvanized	135 x 30 x 10 cm	E532 30	23,00 kg
ST 2000 - Panel plastic E 135/25 galvanized	135 x 25 x 10 cm	E532 25	20,00 kg

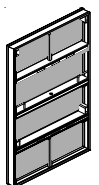

### ST 2000 Multi Purpose Panels

ITEM	DIMENSIONS	ITEM NR.	WEIGHT
ST 2000 - Multi Purpose Panel 270/90 galvanized finnish plywood	270 x 90 x 10 cm	531 901	83,00 kg
ST 2000 - Multi Purpose Panel 135/90 galvanized finnish plywood	135 x 90 x 10 cm	531 903	43,00 kg
ST 2000 - Multi Purpose Panel plastic plywood 270/90 galvanized	270 x 90 x 10 cm	E531 901	87,00 kg
ST 2000 - Multi Purpose Panel plastic plywood 135/90 galvanized	135 x 90 x 10 cm	E531 903	44,00 kg

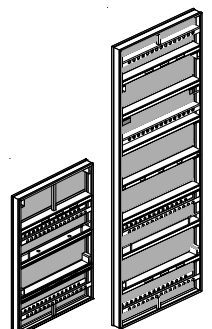

**Other panel widths are available upon request !**

## Corners

### Outside Corners for system 2000

ITEM	DIMENSIONS	ITEM NR.	WEIGHT
Outside Corner 270 galvanized	270 x 10x 10 cm	403V13	26,00 kg
Outside Corner 135 galvanized	135 x 10 x 10 cm	403V23	13,50 kg

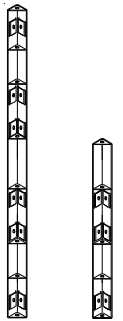

### Inside Corners for system 2000

ITEM	DIMENSIONS	ITEM NR.	WEIGHT
Inside Corner 270/20/20 galvanized with edge profile	270 x 20 x 20 cm	403V11N	46,00 kg
Inside Corner 135/20/20 galvanized with edge profile	153 x 20 x 20 cm	403V21N	28,00 kg

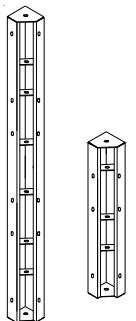

### Outside Articulated Corners for system 2000

ITEM	DIMENSIONS	ITEM NR.	WEIGHT
Articulated Corner 270/10/10	270 x 10 x 10 cm	403 14	40,00 kg
Articulated Corner 135/10/10	135 x 10 x 10 cm	403 24	21,00 kg

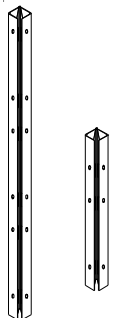

### Inside Articulated Corners for system 2000

ITEM	DIMENSIONS	ITEM NR.	WEIGHT
Articulated Corner 270/20/20	270 x 20 x 20 cm	403 142	63,00 kg
Articulated Corner 135/20/20	135 x 20 x 20 cm	403 242	32,00 kg

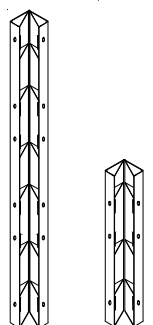

## Dismantling devices; Compensations; Circular Forming Plates

### Dismantling Device for system 2000

ITEM	DIMENSIONS	ITEM NR.	WEIGHT
Dismantling Device 270/10 galvanized	270 x 10 cm	403V28	46,00 kg



### Wall Thickness Compensations for system 2000

ITEM	DIMENSIONS	ITEM NR.	WEIGHT
Wall Thickness Compensation 270/10 cm galvanized	270 x 10 x 10 cm	403V163	17,00 kg
Wall Thickness Compensation 270/5 cm galvanized	270 x 5 x 10 cm	403V16	12,00 kg
Wall Thickness Compensation 270/3 cm galvanized	270 x 3 x 10 cm	403V162	11,00 kg
Wall Thickness Compensation 270/2 cm galvanized	270 x 2 x 10 cm	403V161	10,00 kg
Wall Thickness Compensation 135/5 cm galvanized	135 x 5 x 10 cm	403V26	6,00 kg

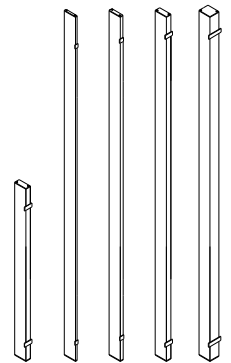

## CIRCULAR FORMING PLATES

### Circular Forming Plates for system 2000

ITEM	DIMENSIONS	ITEM NR.	WEIGHT
Circular Forming Plate 270/25 galvanized	270 x 25 cm	403V52	56,00 kg
Circular Forming Plate 270/20 galvanized	270 x 20 cm	403V51	54,00 kg
Uni - Waler 40 for Circular Forming Plate galvanized		407V94	4,90 kg

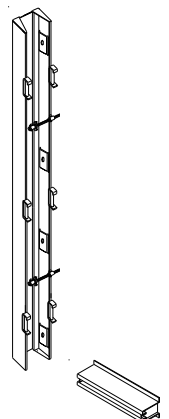

## Connecting material

ITEM		ITEM NR.	WEIGHT
Coupler forged galvanized		404V6	1,70 kg
Adjustable Coupler galvanized	(adjustment range up to 20 cm)	404V61	4,13 kg
Waler 150 galvanized	150 cm	703V152	20,00 kg
Waler 100 galvanized	100 cm	703V151	12,80 kg
RS-Clamp galvanized		704V5	1,60 kg
Double Tenon 60		403 151	6,00 kg
Stop End Coupler galvanized	(wall thickness up to 40 cm)	704V69	8,30 kg
Slab beam clamp galvanized	(for beam up to 70 cm width)	704V66	9,30 kg
Multi Purpose Fixing Bolt galvanized	length = 22 cm	407V91	0,50 kg

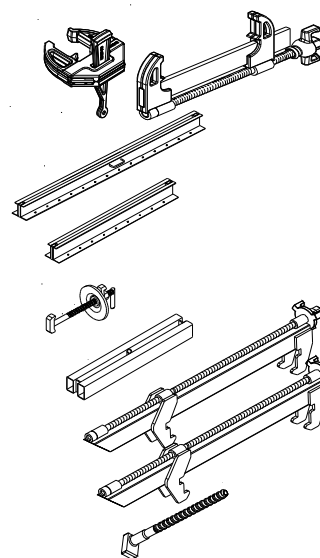

## Anchoring material

ITEM		ITEM NR.	WEIGHT
Tie Rod 1,00 m DW15 galvanized		407 100	1,50 kg
Tie Rod 1,25 m DW15 galvanized		407 125	1,75 kg
Tie Rod 1,50 m DW15 galvanized		407 150	2,15 kg
Tie Rod 2,00 m DW15 galvanized		407 200	3,00 kg
Tie Rod 3,00 m DW15 galvanized		407 300	4,30 kg
Tie Rodl 6,00 m DW15 black		407 600	8,60 kg
Anchor Loop 0,55 m DW15		407 55	1,80 kg
Pigtail anchor DW15	length 550 mm	407 800	0,80 kg
Combi Plate galvanized (ø 120 mm)		407V77	1,00 kg
Wingnut Counterplate galvanized (ø 100 mm)		407V75	0,72 kg
Wingnut galvanized		407V71	0,30 kg
Counter Plate 120 x 120 x 8 mm galvanized		407V73	0,90 kg
Counter Plate KL 60 x 80 x 8 mm galvanized		404V52	0,29 kg
Hexagonal Coupler DW15 galvanized (length = 50mm)		407V8	0,22 kg
Connector for Anchor Loop (length = 11 cm)		407 56	0,60 kg
Foundation Clamp galvanized		703V154	7,50 kg
Perforated Tape for Foundation 1 coil = 25 m		407 500	17,50 kg
Rock Anchor ø 34 - 35 mm	lost part	407 60	0,37 kg
Anchor Fixing Device galvanized		407V62	1,30 kg
Tie Rod Release - Tool DW15-20 galvanized		407V76	1,80 kg

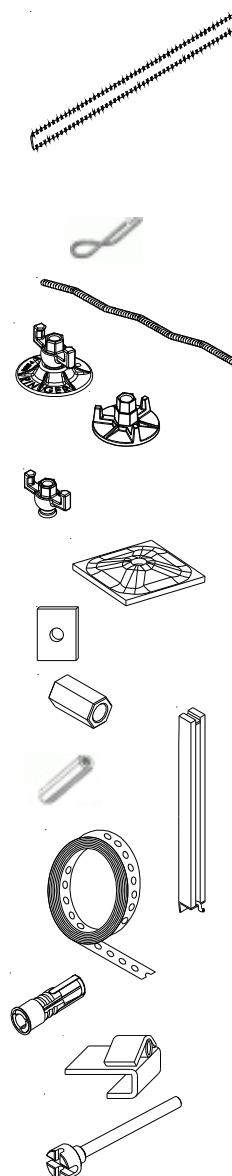

## Push and Pull Props

ITEM		ITEM NR.	WEIGHT
Push and Pull Prop size 1 galvanized	adjustment range 2,00-3,5 m	708V3	29,50 kg
Push and Pull Prop size 2 galvanized	adjustment range 3,10-5,50 m	708V37	55,00 kg
Push and Pull Prop "L" painted 2,10 - 3,60 m		708 36	18,00 kg

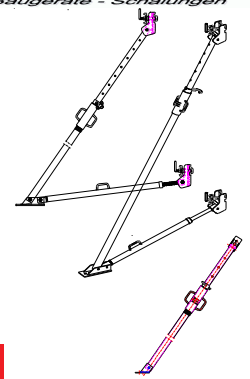

## Brace Frame "L" formwork hight up to 2,70 m

ITEM		ITEM NR.	WEIGHT
Brace Frame "L" unit galvanized	<b>2 m single faced wall / unit</b> 2 x supporting shoe galvanized 2 x anchor block galvanized 2 x adjusting spindle galvanized 2 x supporting tube 245 cm galvanized 3 x Uni-Waler 200 galvanized 1 x Uni-Waler 150 galvanized 4 x Uni-Waler 150 for Brace Frame "L" 20 x Connecting bolts + Spring cotters 8 x RS-Clamp galvanized 2 x Anchor Loop 0,55 m DW15 4 x Connector for Anchor Loop DW15 4 x Tie Rod 1,00 m DW15 galvanized 4 x Combiplate galvanized	409V3	238,00 kg

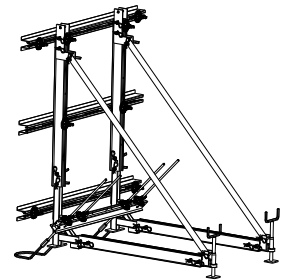

## Concreting Brackets

ITEM		ITEM NR.	WEIGHT
Bracket without Hand Rail Post galvanized		708V11	7,70 kg
Hand Rail Post for Bracket galvanized		408V12	3,90 kg
Concreting Platform "L" 2,70 m (ready unit)		708v20	66,00 kg

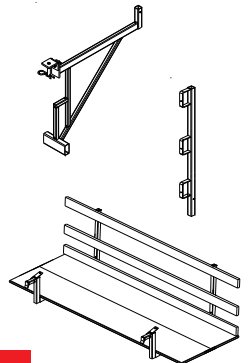

## Crane Hook for system 2000

ITEM		ITEM NR.	WEIGHT
Crane Hook galvanized		408V4	6,00 kg

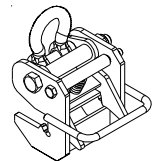

## Transport and Storage Pallets

ITEM		ITEM NR.	WEIGHT
Box for Alu Formwork galvanized	for example 10 x Alu-2000 Frame Panels 270/90	408V90	80,00 kg
Stirrup for Box galvanized		408V91	4,20 kg
Accessory Box galvanized	(1970x 1190 x 630 mm)	260V0006	160,00 kg
Uni - Container galvanized (with flap)	(1200 x 800 x 770 mm)	260V10	72,00 kg
Uni - Container galvanized (without flap)	(1200 x 800 x 770 mm)	260V11	70,00 kg
Ringer Multi Purpose Container galvanized (without flap)	(1140 x 740 x 770 mm)	260V12	66,00 kg

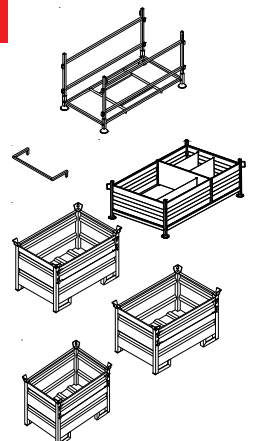

## Release Agent and Syringe

ITEM		ITEM NR.	WEIGHT
Release Agent Alu 2000	canister 25 liter from 24 canisters (1 Palett)	450 1	22,50 kg
	drum 200 liter from 3 drums	450 11	180,00 kg
Syringe for Release Agent complete (5 liter)		408 8	5,00 kg



Special spare parts upon request!

## Spacer Tubes

ITEM		ITEM NR.	WEIGHT
Spacer Tube WD 15 cm (set)	packing unit: 50 pcs.	441 42	2,00 kg per 50 pcs.
Spacer Tube WD 20 cm(set)	packing unit: 50 pcs.	441 43	3,00 kg per 50 pcs.
Spacer Tube WD 25 cm (set)	packing unit: 100 pcs.	441 4	4,50 kg per 100 pcs.
Spacer Tube WD 30 cm (set)	packing unit: 50 pcs.	441 41	5,00 kg per 50 pcs.
Spacer Tube WD 40 cm (set)	packing unit: 50 pcs.	441 44	6,50 kg per 50 pcs.
Cone for Spacer Tube waterproof (long)	packing unit: 100 pcs.	441 15	0,30 kg per 100 pcs.
Spacer Tube length 23 cm for 25 cm wall	packing unit: 200 pcs.	441 32	10,00 kg per 200 pcs.
Spacer Tube length 28 cm for 30 cm wall	packing unit: 200 pcs.	441 33	12,00 kg per 200 pcs.
Spacer Tube ø24/2 mm length 2 m	packing unit: 25 pcs. (=50lm.)	441 31	11,00 kg per 50 m.
Tie Cone ø 20 mm	packing unit: 500 pcs.	441 2	1,00 kg per 500 pcs.
Tie Cone ø 20 mm black	packing unit: 500 pcs.	441 1	1,00 kg per 500 pcs.

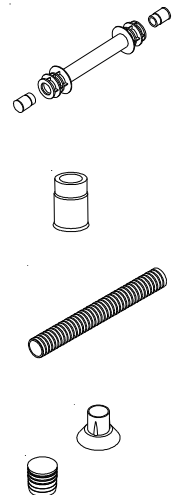

## Cones

ITEM		ITEM NR.	WEIGHT
Tie Cone ø 20 mm black	packing unit: 500 pcs.	441 1	1,00 kg per 500 pcs.
Tie Cone ø 24 mm brown for Multi Purpose Panel	packing unit: 200 pcs.	441 14	0,60 kg per 200 pcs.



## ADDITIONAL ACCESSORIES

### Carbide Scrapers

ITEM		ITEM NR.	WEIGHT
Carbide Scraper with reversing Plate width 10 cm, shaft length 1,3 m		408 5	1,40 kg
Carbide Scraper with reversing Plate width 10 cm, shaft length 0,8 m		408 51	1,20 kg

